

# Assessment of Physico-chemical and Bacteriological Parameters of Drinking Water from Different Sources in Mysore City

D. Sunitha, S. Mahadeva Murthy, K.S. Divya, A. Ramalingam

Department of Civil Engineering, SCMS School of Engineering and Technology, Ernakulam, Kerala, India

**ABSTRACT:** Reinforced concrete deep beams are widely used as transfer girders in offshore structures and foundations, walls of bunkers and load bearing walls in buildings. The existence of web openings interrupt the natural load path and reduces the shear capacity of the structural element. This paper aims to develop three dimensional nonlinear finite element models for reinforced concrete deep beams with web openings externally bonded using Basalt Fibre Reinforced Polymer (BFRP) composite sheets. The FRP strengthened structures may fail by de-bonding of fibres from the concrete surface. Mechanical anchoring systems has been introduced in order to prevent the de-bonding of FRP composite sheets from the beam surface. Realistic material constitutive laws were adopted for the finite element models to simulate the nonlinear behavior of materials. A total of sixteen finite element models were analyzed. The size and shape of the openings varied for different models. Square openings of sizes 180 x 180mm & 120 x 120mm and circular openings of diameter 160mm & 100mm were provided. Two strengthening configurations were also included in the study. Externally bonded basalt fiber reinforced polymer sheets were found to be very effective in enhancing the shear strength of the RC deep beams. Increase in the opening size, regardless of the shape led to the reduction in the shear strength of the beams. The strength gain caused by the BFRP sheets was in the range 23.5 % - 136.36 %. The mechanical anchors was found to be effective in preventing the de bonding failure.

**KEYWORDS:** Strengthening, BFRP, Openings, Deep beams, Mechanical anchors.

## I. INTRODUCTION

A beam with the depth comparable to the span length is considered as a deep beam. Reinforced concrete deep beams find its applications in offshore structures, tall buildings, walls of bunkers, foundations etc. The creation of web openings is often required for the accommodation of electrical and mechanical conduits. The existence of openings cause geometric discontinuity and also the current code of practices do not include the provision for design of deep beams with openings. The presence of web openings in deep beams leads to early diagonal cracking and also in the significant reduction in the shear strength. There are two types of openings 1) Pre planned openings 2) Post planned openings. In pre-planned openings the size and location of the opening will be known during the design stage itself. In this case adequate internal strengthening can be provided during the design stage itself. But in the case of post planned openings internal strengthening is not applicable. The only possible criteria is to externally strengthen the structural element using fibre reinforced polymer. This is the only method which can be used to regain the strength of the element up to the original capacity. From the previous experimental studies it is clear that reinforced concrete deep beams strengthened by FRP composites fail by de bonding of the fibers from the beam surface. To avoid such failures mechanical anchoring systems has been introduced to securely attach the FRP to the beam surface.

A recent increase in the use of ecofriendly, natural fibers as reinforcement for the fabrication of lightweight, low cost polymer composites can be seen globally. One such material of interest currently being extensively used is basalt fiber, which is cost effective and offers exceptional properties over glass. This thesis paper makes an attempt to introduce Basalt fibre reinforced polymer composite for strengthening purposes. BFRP has several advanced properties making it a very favourable material in structural applications. Two strengthening configurations such as U shaped wrapping and Double side wrapping of FRP is used in this study.

The study conducted by Tamar El Maaddawy et.al [1] reported that the use of externally bonded carbon fiber polymer composite sheets was found to be very effective in upgrading the shear strength of RC deep beams. The strength gain caused by the CFRP sheets was in the range of 35% - 73%. Qudeer Hussain et.al [2] conducted an experimental study on Shear strengthening of RC deep beams with openings using sprayed glass fiber reinforced polymer composites. Mechanical anchors were used to prevent the de-bonding of FRP from the beam surface. From the studies, it was reported that the use of mechanical anchors were effective in preventing the de-bonding failure thereby increasing the ultimate load carrying capacity of the deep beams. M. R Islam et.al [3] reported that the use of FRP systems leads to a much slower growth of the

critical diagonal cracks and enhances the load carrying capacity of the beam to a level quite sufficient to meet most of the practical upgrade requirements.

## II. RELATED WORK

Qudeer Hussain et.al [2] conducted an experimental study on Shear strengthening of RC deep beams with openings using sprayed glass fiber reinforced polymer composites. Mechanical anchors were used to prevent the de-bonding of FRP from the beam surface. From the studies, it was reported that the use of mechanical anchors were effective in preventing the de-bonding failure thereby increasing the ultimate load carrying capacity of the deep beams. From the literature works, it is clear that greater part of the investigations were on carbon fibre reinforced polymers and glass fibre reinforced polymer used for strengthening purposes. Only limited number of literature works were available on deep beams strengthened with FRP sheets and mechanical anchors. This paper exhibits the numerical study of shear strengthened RC deep beams with Basalt fibre reinforced polymer composite sheets. The numerical simulation of mechanical anchors is also done using the software. Two different strengthening configurations were included in the study. The effect of opening sizes and shapes were also examined.

## III. MECHANICAL ANCHORING SYSTEMS

From the literature works it is clear that reinforced concrete deep beams strengthened by FRP composites fail by de-bonding of the fibers from the beam surface. To avoid such failures mechanical anchoring systems are being introduced to securely attach the BFRP to the beam surface. The commonly used anchoring systems include Through Bolt Anchoring systems (TB), Mechanical Expansion Bolt Anchoring systems (MB) and Epoxy Bolt Anchoring systems (EB). Fig. 1 shows the different types of anchoring systems.

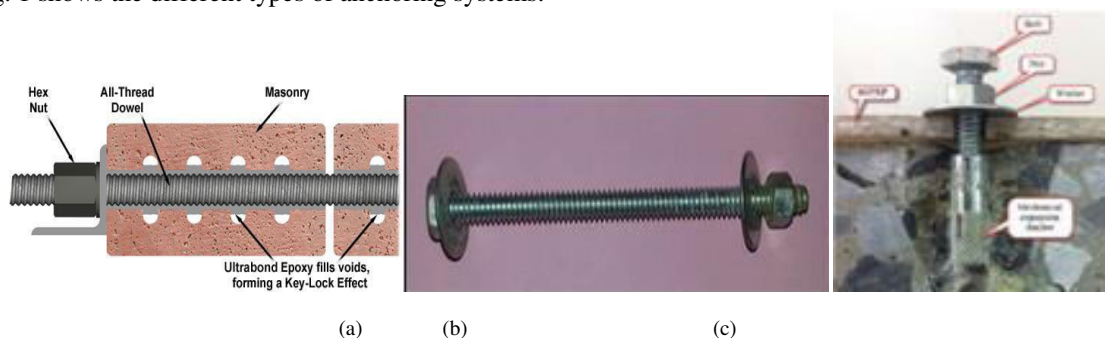

Fig. 1.(a) Epoxy Bolt Anchoring Systems (b) Through Bolt Anchoring Systems (c) Mechanical Expansion Bolt Anchoring systems

Mechanical expansion bolt anchors proposed by Hussain and Pimanmas (2014) is used to avoid the de-bonding of FRP from the concrete surface. Mechanical anchors with a diameter of 7mm and a length of 25mm, full threaded hex headed bolts with a diameter of 4mm and a length of 35mm and nuts and washers are used in their study. The MB anchoring system develops the bond force through the frictional resistance between the mechanical expansion anchors and concrete. In this paper the effective simulation of these mechanical anchors has been done using ANSYS 16.2 Software. These anchors are placed at a distance of 110mm centre to centre in both horizontal and vertical directions. These mechanical anchors as such were not modelled instead their effect were properly simulated in the software.

## IV. OBJECTIVES OF THE PRESENT WORK

- 1) To identify the correlation of the results obtained from the developed model and experimented results.
- 2) Effectiveness of anchoring system on the behaviour of FRP strengthened RC deep beams with openings.
- 3) To study the effect of various opening sizes and shapes.
- 4) Significance of different strengthening configurations on the behaviour of FRP strengthened RC deep beams with openings.

## V. METHODOLOGY

- 1) Validation of finite element analysis of FRP strengthened RC deep beam with openings based on the study done by Qudeer Hussain and AmornPimanmas (2015) on paper titled "*Shear Strengthening of RC Deep Beams*"

with Openings using Sprayed Glass Fiber Reinforced Polymer Composite (SGFRP): Part 1. Experimental Study”.

- 2) Finite element analysis of FRP strengthened RC deep beams with openings.
- 3) Interpretation of results.

### VI. ANALYTICAL STUDY

The FE models consisted of sixteen RC deep beams with openings of different shapes and sizes. The specimens were divided into four groups (A, B, C and D) according to the opening shape and size. Each group consisted of four RC deep beams with openings. One specimen in each group was used as a control unstrengthen specimen. The compressive strength of specimens in group A, B, C and D were 25MPa. The model of deep beam used in this thesis paper is taken from the study done by Qudeer Hussain and AmornPimanmas (2015) on paper titled "Shear Strengthening of RC Deep Beams with Openings using Sprayed Glass Fiber Reinforced Polymer Composite (SGFRP): Part 1. Experimental Study". The cross section of all the deep beams were width = 100 mm and total depth = 500 mm. The total span length of the beam was 870 mm, and the shear span length was 435 mm. Two opening shapes (i.e., circular and square) were used with two different sizes for each shape. The size of the square opening was 120 × 120 mm and 180 × 180 mm, and the diameter of circular opening was 100 mm and 160 mm. In all specimens, one opening is provided at the centre of each shear span. Each beam contained two numbers 12mm diameter bars (yield strength of 415 MPa) at the bottom face, and top two number 6mm diameter bars (yield strength of 250 MPa) at the top face. The web reinforcements consisted of 6mm diameter bars provided at 110 mm spacing in both vertical and horizontal directions. Stirrups were used as the vertical web reinforcement, and straight bars were used as the horizontal web reinforcement. Closely spaced vertical stirrups were provided at both ends of the beams to avoid premature failure at these locations.

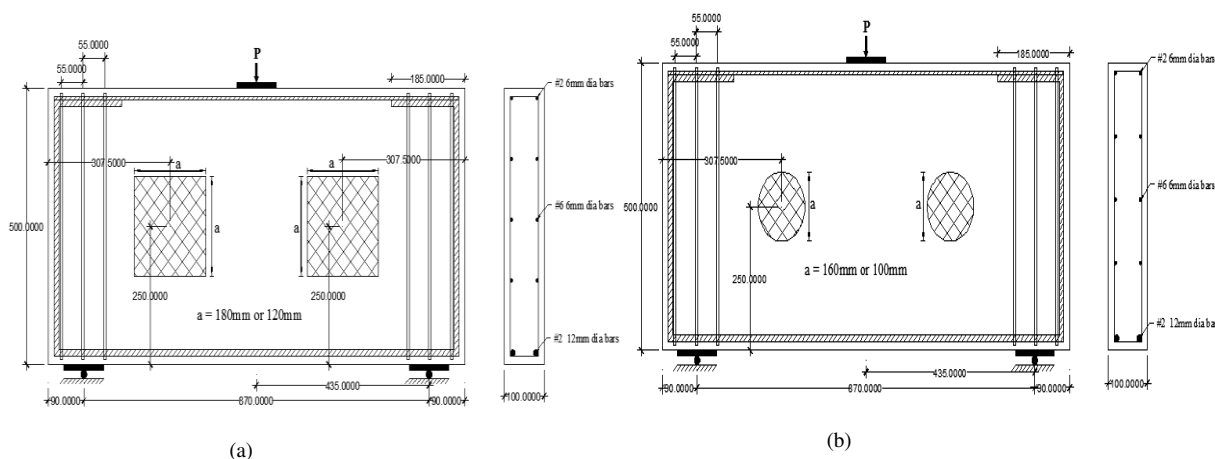

Fig. 2 (a) Group A and B beam detailing (units in mm) (b) Group C and D beam detailing (units in mm).

Fig. 2 shows the beam detailing of groups A, B, C, D. A clear 15mm thick concrete cover was provided in all sides of beams. Each specimen was assigned a designation that represented the strength of concrete, the fiber thickness, the strengthening configuration, the shape and size of the opening. As an example a specimen designation FE-1.05A-S18-WMA was interpreted as follows: FE-finite element model, 1.05A - 1.05mm thickness of FRP with strengthening configuration A, S indicated a square opening with a size of 180 × 180 mm and WMA as without mechanical anchors.

Table 1: Group A and B specimen

Group	Beam	Size of square opening (mm)	FRP configuration
A	Control FE-S18	180 × 180	-
	FE-1.05A-S18	180 × 180	A
	FE-1.05A-S18-WMA	180 × 180	A
	FE-1.05B-S18	180 × 180	B
B	Control FE-S12	120 × 120	-

## || Volume 8, Issue 1, January 2021 ||

	FE-1.05A-S12	120 × 120	A
	FE-1.05A-S12-WMA	120 × 120	A
	FE-1.05B-S12	120 × 120	B

Table 2: Group C and D specimen

Group	Beam	Size of circular opening (mm)	FRP configuration
C	Control FE-C16	160	-
	FE-1.05A- C16	160	A
	FE-1.05A- C16-WMA	160	A
	FE-1.05B- C16	160	B
D	Control FE-C10	100	-
	FE-1.05A- C10	100	A
	FE-1.05A- C10-WMA	100	A
	FE-1.05B- C10	100	B

Table 1 and 2 shows the finite element models in different groups.

## VII. FINITE ELEMENT ANALYSIS

Finite element model of the RC deep beams with openings and mechanical anchors were built and analyzed using ANSYS 16.2 software. Deep beams were modelled as simply supported beams. Steel plates were provided at the supports and also at the loading locations. Steel plates were provided in order to avoid stress concentration problems and to prevent localized crushing of concrete elements near the supporting points and load application locations.

**Element Types:** The concrete was modelled using the element SOLID65. This element is capable of modelling the nonlinear behaviour of concrete in tension and compression. The element SOLID65 has eight nodes, each having three translational degrees of freedom. The steel reinforcing bars were modelled using the element LINK8. This element is defined by two nodes, each having three translational degrees of freedom. The BFRP sheets were modelled using the element SHELL99. This element is capable of modelling multi-layers structural shells. The element SHELL99 accommodates up to 250 layers. It has eight nodes, each having six degrees of freedom. The loading and support plates were modelled using the element SOLID45. This element is defined by eight nodes, each having three translational degrees of freedom. The mechanical anchors were modelled using beam elements. These beam elements securely attach the FRP to the concrete surface. The epoxy layer was modelled using the interface element INTER205. This interface element has a zero thickness. It is defined by eight nodes, each having three translational degrees of freedom. The element INTER205 was used to simulate the interfacial bond-slip action between the concrete and BFRP.

**Nonlinear solution:** The load applied was divided into a series of load increments (or) load steps. Newton – Raphson equilibrium iterations provide convergence at the end of each load increment within tolerance limits. The automatic time stepping in the ANSYS program predicts and controls load step sizes for which the maximum and minimum load step sizes are required. After attempting many trials the number of load steps, minimum and maximum step sizes was determined. During concrete cracking, steel yielding and ultimate stage in which large numbers of cracks occur the loads were applied gradually with smaller load increments.

VIII. DEEP BEAMS WITH SQUARE OPENINGS

Fig. 3 shows the loading diagram, meshing, support conditions and deflection diagram of FE1.05A-S18 model.

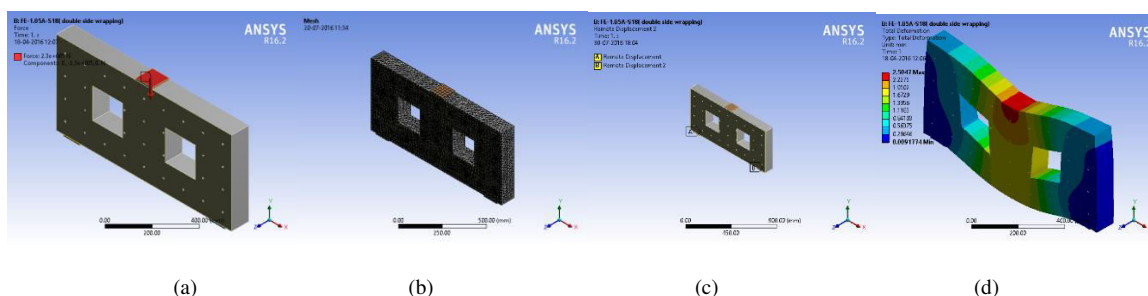

Fig. 3 (a) Loading diagram of FE-1.05A-S18 model (b) Meshing of the model (c) Support conditions (d) Deflection diagram of FE-1.05A-S18 model

IX. DEEP BEAMS WITH CIRCULAR OPENINGS

Fig. 4 shows the loading diagram, meshing, support conditions and deflection diagram of FE-1.05A-C16 model.

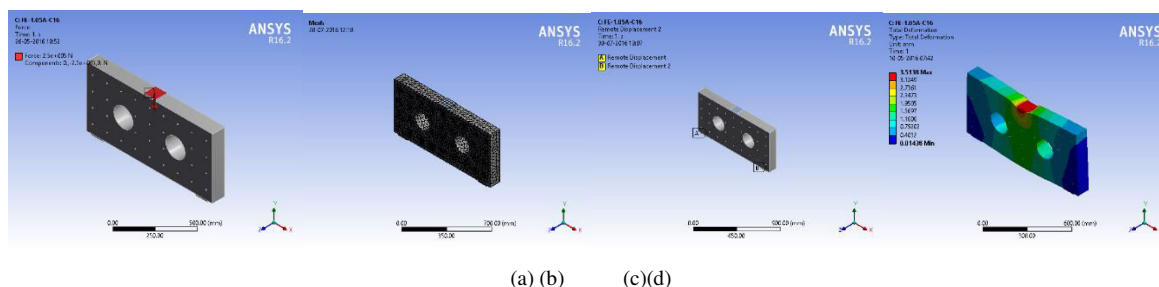

Fig. 4 (a) Loading diagram of FE-1.05A-C16 (b) Meshing of the model (c) Support conditions (d) Deflection diagram of FE-1.05A-C16 model

Table 3 shows the results obtained for different models after analysing in ANSYS software. The peak load, increased peak load and deflection obtained for different models is shown.

Table 3: Finite Element Results

Group	Beam	Peak Load (kN)	Increased Peak Load (%)	Deflection (mm)
A	Control FE-S18	110	-	1.7
	FE-1.05A-S18	230	109.09	2.50
	FE-1.05A-S18-WMA	170	54.54	2.16
	FE1.05B-S18	260	136.36	2.90
B	Control FE-S12	150	-	2.00
	FE-1.05A-S12	260	73.33	3.24
	FE-1.05A-S12-WMA	210	40	2.55
	FE1.05B-S12	290	93.33	3.38
C	Control FE-C16	170	-	2.3
	FE-1.05A-C16	250	47.05	3.5
	FE-1.05A-C16-WMA	210	23.5	2.68
	FE1.05B-C16	270	58.85	3.79
D	Control FE-C10	190	-	2.65
	FE-1.05A-C10	290	52.63	3.95

	FE-1.05A-C10-WMA	240	26.31	3.22
	FE1.05B-C10	320	68.42	4.32

X. RESULTS AND DISCUSSIONS

**Models in Group A:** Models in group A are reinforced concrete deep beams with 180mm × 180 mm square openings. The control beam failed at the peak load of 110 kN. For FE-1.05A-S18-WMA model the ultimate load obtained was 170 kN and for FE-1.05A-S18 model the ultimate load obtained was 230 kN. Similarly the ultimate load obtained for FE-1.05B-S18 model was 260 kN. The minimum load increase of 54.54 % was obtained for the model FE-1.05A-S18-WMA, 109.09 % of load increase for the model FE-1.05A-S18 and the maximum load increase of 136.36 % for the model FE-1.05B-S18.

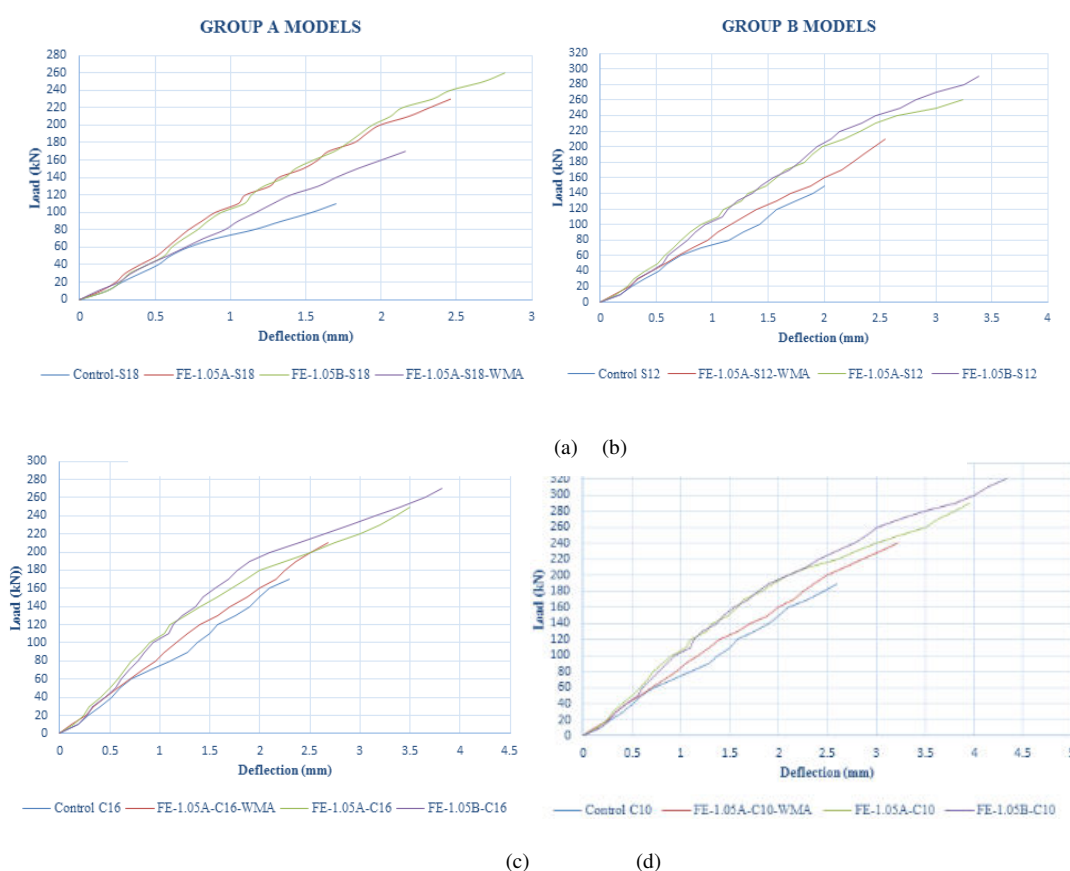

Fig. 5 (a) Load deflection curve for Group A models (b) Load deflection curve for Group B models (c) Load deflection curve for Group C models (d) Load deflection curve for Group D models

Figure 5 shows load deflection curve for Group A, Group B, Group C and Group D models

**Models in Group B:** Models in group B are reinforced concrete deep beams with 120mm × 120 mm square openings. The control beam failed at the peak load of 150 kN. For FE-1.05A-S12-WMA model the ultimate load obtained was 210 kN and for FE-1.05A-S12 model the ultimate load obtained was 260 kN. Similarly the ultimate load obtained for FE-1.05B-S12 model was 290 kN. The minimum load increase of 40 % was obtained for the model FE-1.05A-S12-WMA, 73.38 % of load increase for the model FE-1.05A-S12 and the maximum load increase of 92.33 % for the model FE-1.05B-S12.

**Models in Group C:** Models in group C are reinforced concrete deep beams with 160 mm diameter circular openings. The control beam failed at the peak load of 170 kN. For FE-1.05A-C16-WMA model the ultimate load obtained was 210 kN and for FE-1.05A-C16 model the ultimate load obtained was 250 kN. Similarly the ultimate load obtained for FE-1.05B-C16 model was 270 kN. The minimum load increase of 23.5 % was obtained for the model FE-1.05A-C16-

WMA, 47.85 % of load increase for the model FE-1.05A-C16 and the maximum load increase of 58.22 % for the model FE-1.05B-C16.

**Models in group D:** Models in group D are reinforced concrete deep beams with 100 mm diameter circular openings. Figure 8.4 shows the Load Deflection curve for all the models in group D. The control beam failed at the peak load of 190 kN. For FE-1.05A-C10-WMA model the ultimate load obtained was 240 kN and for FE-1.05A-C10 model the ultimate load obtained was 290 kN. Similarly the ultimate load obtained for FE-1.05B-C10 model was 320 kN. The minimum load increase of 26.31 % was obtained for the model FE-1.05A-C16-WMA, 52.63 % of load increase for the model FE-1.05A-C16 and the maximum load increase of 68.42 % for the model FE-1.05B-C16.

**Effectiveness of Anchoring systems:** In group A models, load increase of 35.29 % was obtained for the model with mechanical anchors having same strengthening configuration. In group B models the load increase was 23.80 %, in group C it was 19.64 % and in group D it was 23.83 % respectively. The FE models of the strengthened deep beams without mechanical anchors failed by de-bonding of FRP sheets. But for the models with anchors no pull out was observed prior to the rupture of fiber. Fig 6 shows the effect of anchoring system in load carrying capacity of deep beams.

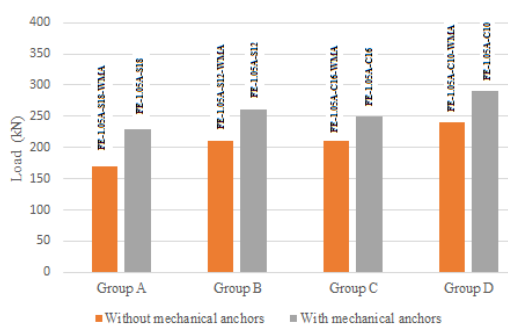

(a)

Fig. 6 (a) Effect of anchoring systems in the load carrying capacity of deep beams

**Effect of opening size and shape:** From the finite element results, it is clear that increase in the opening size, regardless of the shape, led to the reduction in beam’s shear strength. For both strengthened and unstrengthen beams the strength decrease was observed. Fig. 7 shows the effect of opening size and shape.

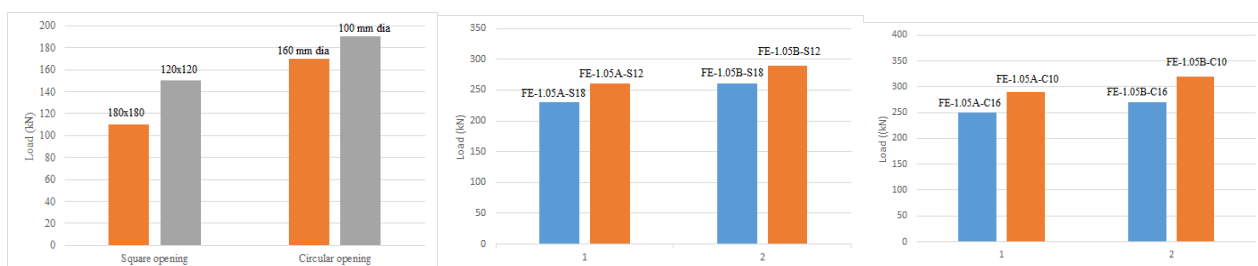

(a) (b)(c)

Fig. 7 (a) Effect of opening size and shape (control beams) (b) Effect of opening size and shape (BFRP strengthened beams with square openings) (c) Effect of opening size and shape (BFRP strengthened beams with circular openings).

**Effect of strengthening configurations:** Two strengthening configurations namely configurations A and B were studied. From the results we can see that the strengthening configuration B demonstrates a consistently superior performance over strengthening configuration A. This is because U shaped wrapping of FRP ensures better bonding to the concrete surface than double side wrapping. Fig. 8 shows the effect of strengthening configurations.

## || Volume 8, Issue 1, January 2021 ||

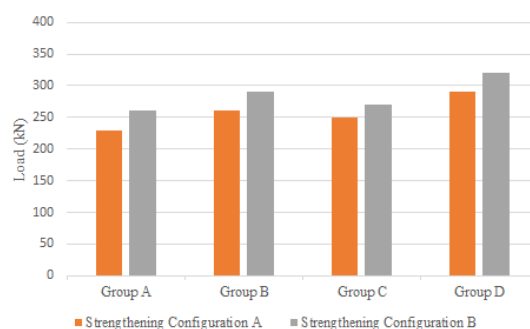

(a)

Fig. 8 (a) Effect of BFRP strengthening configurations.

## XI. CONCLUSIONS

This thesis paper presents a numerical study on the use of externally bonded Basalt Fiber Reinforced Polymer (BFRP) composites for strengthening of RC deep beams with opening. Different sizes and shapes of openings made in the web were investigated. Based on the numerical results and discussions, the following conclusions could be drawn,

- The externally bonded BFRP was remarkably effective to increase the ultimate load of the RC deep beams with both the square and circular openings. The load increase of deep beams with BFRP was in the range of 26.31 % - 136.36 % for models in different groups.
- Mechanical anchors significantly increases the ultimate load carrying capacity of the FRP strengthened RC deep beams. The load increase of deep beams with same strengthening configuration and with mechanical anchors was in the range of 19.64 % - 35.29 % for models in different groups. Anchoring systems was effective in preventing the de bonding failure.
- The strengthening configurations A and B increase the shear strength of RC deep beams with openings. Strengthening configuration B was superior to the configuration A. From the results it was observed that a load increase of 8 % -13 % was observed for models in different groups.
- The increase in the opening size, regardless of the shape, led to the reduction in beam's shear strength. For both strengthened and unstrengthen beams the strength decrease was observed.
- For control beams with square openings, when the size is increased by 1.5 times (i.e. From 120mm x 120mm to 180mm x 180mm) the reduction in load carrying capacity was 26.26 %. And for control beams with circular openings, when the size is increased by 1.6 times (i.e. From 100mm dia to 160mm dia) the reduction in load carrying capacity was 10.52 %.
- For strengthened beam with square openings and configuration A the reduction in load carrying capacity was 11.53 % and for circular openings it was 13.79 %.
- For strengthened beam with square openings and configuration B the reduction in load carrying capacity was 10.34 % and for circular openings it was 15.625 %.

## REFERENCES

- [1] Tamer, Sayed, "FRP composites for shear strengthening of reinforced concrete deep beams with openings", Journal of composite structures, Volume 89, pp. 60-69, 2009.
- [2] Hussain, Q. and Pimannas, A. "Shear strengthening of RC deep beams with Sprayed Glass Fiber Reinforced Polymer Composites (SGFRP): Part 1. Experimental study." KSCE journal of civil engineering, Volume 19(7), pp. 2121-2133, 2015.
- [3] M.R.Islam, M.A.Mansur, M.Maalej, "Shear strengthening of RC deep beams using externally bonded FRP systems", Volume 27, pp. 413-420, 2005.
- [4] Rami A Hawileh, "Nonlinear finite element modelling of concrete deep beams with openings strengthened with externally bonded composites", Journal of composite structures, Volume 42, pp. 378-387, 2012.