



International Journal of Advanced Research in Education and Technology (IJARETY)

Volume 11, Issue 6, November-December 2024

Impact Factor: 7.394



EV Charging Station with RFID Based

Prof. Pawale Sunil Suresh, Prof. Giri Datta Yashawant

Department of Electrical Engineering, Sau. Sundarbai Manik Adsul Polytechnic, Chas, Ahmednagar,
(Maharashtra), India

ABSTRACT: The development of cost-effective green vehicle technology, such as electric vehicles has been prompted by the need for a cleaner environment. As the number of electric vehicles (EVs) on the road rises, charging infrastructure becomes increasingly important. The electric vehicle charging system has a number of issues, including ways to improve its operation and efficiency and a better understanding of current EV charging habits. As a result, this paper employs RFID (radio frequency identification) technology, which allows users to be automatically identified. Electromagnetic waves are used to transmit and receive data from users in this technology. The aim of RFID based EV Charging station is that the system exploits opportunities of connectivity to computation capabilities of big data (because we are using google sheet for store the information). Firstly, a source data to support defining use cases that represent driving patterns and functionality. Second, connection to big data and computation capabilities in cloud enables optimizing the EV energy which leads to a reliable range prediction, eco-driving, eco routing as well as novel functionalities like smart fast charging

KEYWORDS: EV Charger RFID Reader RFID Cards/Tags

I. INTRODUCTION

An electric vehicle charging station is equipment that connects an electric vehicle (EV) to a source of electricity to recharge electric cars, neighborhood electric vehicles and plug-in hybrids. Some charging stations have advanced features such as smart metering, cellular capability, and network connectivity, while others are more basic. Charging stations are also called electric vehicle supply equipment (EVSE) and are provided in municipal parking locations by electric utility companies or at retail shopping centers by private companies. These stations provide special connectors that conform to the variety of electric charging connector standards. Fees for using EVSE vary from monthly or yearly flat rates to per-kWh to hourly rates. Charging stations can be free and are usually subsidized by the local government. Different types of EVSE provide different speeds of charging. Level 1 charging stations use a 120-volt (V), alternating-current (AC) plug and require a dedicated circuit, offering about 5 miles of range for every hour of charging. Level 2 stations charge through a 240V, AC plug and require home charging or public charging equipment to be installed. Level 2 stations provide 10 to 20 miles of range for every hour of charging. Level 2 chargers are the most common and charge at approximately the same rate as a home system. Level 3 chargers are also known as DC fast chargers. Level 3 uses a 480V, direct-current (DC) plug. They bypass the onboard charger and provide DC electricity to the battery via a special charging port. DC Fast Chargers provide up to 40 miles of range for every 10 minutes of charging but are not compatible with all vehicles. Additionally, some propriety charging stations, such as the Tesla Supercharger, are designed for significantly higher-speed charging. As demand grows for more publicly accessible charging stations, there is a greater need for equipment that supports faster charging at higher voltages and currents that are not currently available from residential ESVE. Globally, the number of electric vehicle networks is increasing to provide a system of publicly accessible charging stations for EV recharging. Governments, automakers and charging infrastructure providers have forged agreements to create these networks. Using a microcontroller, relays, and an RFID, we created a simple charging station for electric vehicles that can enable charging for the user's vehicle. This RFID charging station authorization system makes charging at a charging station simple and convenient for a user. The technical advantages of RFID technology for identifying electric vehicles and managing the entire battery charging compartment, as well as how RFID technology is used in battery charging stations.

Because of these advantages, RFID technology can better serve the electric vehicle industry and support effective battery charging compartment management. Electric vehicle charging stations have begun to be installed in many areas, but they are not yet complete. This method reduces operation time by incorporating an RFID system at the charging station, which allows for automatic user authorization. As demand grows for more publicly accessible charging stations, there is a greater need for equipment that supports faster charging at higher voltages and currents that are not currently available from residential ESVE. Globally, the number of electric vehicle networks is increasing to provide a

system of publicly accessible charging stations for EV recharging. Governments, automakers and charging infrastructure providers have forged agreements to create these networks.

II. RELATED WORK

As the number of EVs on the road increases, charging stations in both parking structures and private garages will become more prevalent. These stations will be responsible for meeting the requirements of the distribution grid, EV owners, and parking structure operators. For security and financial reasons, among the many functions these charging stations will perform are user authorization, authentication, and billing. Other commercial charging stations, such as Coulomb and Blink require a short-range RFID card for the same purpose. In both cases, extra steps on the part of the user must be taken to authorize charging. The authors propose using conventional RFID tags inside EVs and RFID readers on parking garage access gates together with middleware and an aggregate charging controller to authorize, assign, and enable charging. However, this system still requires action from the user and is not as flexible as may be desired.

The proposed improvements allow charging authorization to take place seamlessly at multiple charging stations in a single geographic location without any action on the part of the user. Vehicle Monitoring/Identification Modules (VMMs), located in EVs, act as RFID tags for vehicle identification and charging authorization. The Internet of Things, also called things- linked internet, it refers to a kind of network that adopts RFID (radio frequency identification) and to enable the linkage between any articles and the internet, to enable the exchange and communication of information.

III. METHODOLOGY

This paper aims to discuss the application of RFID technology in the battery charging stations and analyze the technical advantages of RFID technology in the electric vehicle identification as well as the unified management of the battery charging compartment. Here for the output power supply SMPS (switching mode power supply) is The Internet of Things, also called things-linked internet, it refers to a kind of network that adopts RFID.

Radio-frequency identification (RFID) uses electromagnetic fields to automatically identify and track tags attached to objects. An RFID system consists of a tiny radio transponder, a radio receiver and transmitter. When triggered by an electromagnetic interrogation pulse from a nearby RFID reader device, the tag transmits digital data, usually an identifying inventory number, back to the reader. This number can be used to track inventory goods.

The working model of an electric vehicle charging station consists of a microcontroller, RFID, power supply circuit, and a set of relays. The 328 microcontroller is in charge of relay switching. When different push buttons are pressed, the microcontroller is programmed to connect the charger to the electric vehicle for a specific amount of time before disconnecting it and a amount is deducted from the user’s account. Every button deducts an amount of Rs 10, 20 a so on from the user account. The initial amount in users’ card is 100.

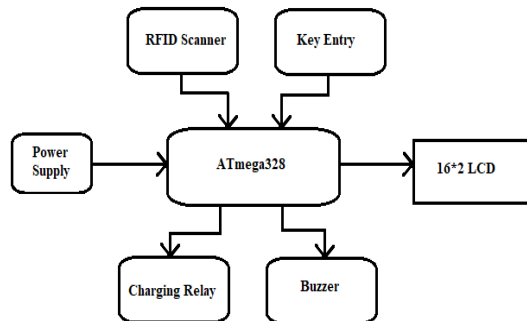

Fig 1: Block Diagram of our proposed system

An RFID-based EV charging station typically consists of the following components: RFID Reader: This device reads the RFID tags/cards attached to the electric vehicles. It communicates wirelessly with the RFID tags to obtain unique identification information.

Controller: The controller processes the information received from the RFID reader and manages the charging process accordingly. It verifies the identity of the vehicle owner and authorizes the charging session.

Power Supply: This component provides the necessary electrical power to the charging station. It may connect to the grid or utilize alternative energy sources such as solar panels.

Charging Unit: This is the physical infrastructure where the electric vehicle connects to charge its batteries. It regulates the flow of electricity to the

1. Vehicle based on the charging protocol and commands from the controller.
2. RFID Tags/Cards: Each electric vehicle owner possesses an RFID tag or card containing unique identification information. These are scanned by the RFID reader to initiate the charging process.
3. Communication Interface: This component facilitates communication between the charging station and external systems, such as billing systems or monitoring platforms. It may utilize protocols like Wi-Fi, Ethernet, or cellular networks.

Overall, the block diagram illustrates how the RFID reader, controller, power supply, charging unit, RFID tags/cards, and communication interface work together to enable secure and efficient charging of electric vehicles

IV. EXPERIMENTAL RESULTS

4.1 OVERALL SYSTEM PROTOTYPE:

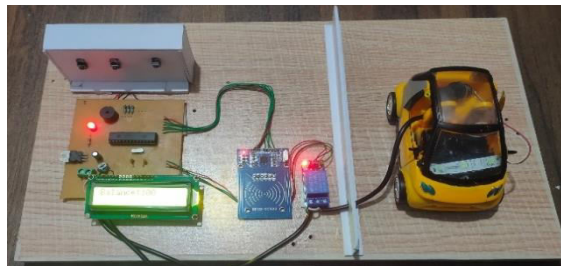

Fig 2: System prototype of RFID based EV charging station.

4.2 WORKING:

STEP 1: System welcomes customer and ask to scan your card.



Fig 2: System prototype of RFID based EV charging station.

STEP 2: After scanning RFID card system recognize you and greet on display with registered name.

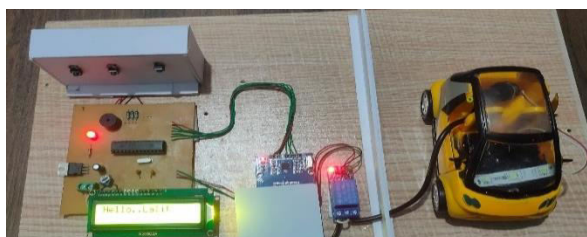

Fig 3: System prototype of RFID based EV charging station.

STEP 3: After greeting on LCD display we can see our balance on card and according to that we can decide for how much time we can charge our car.

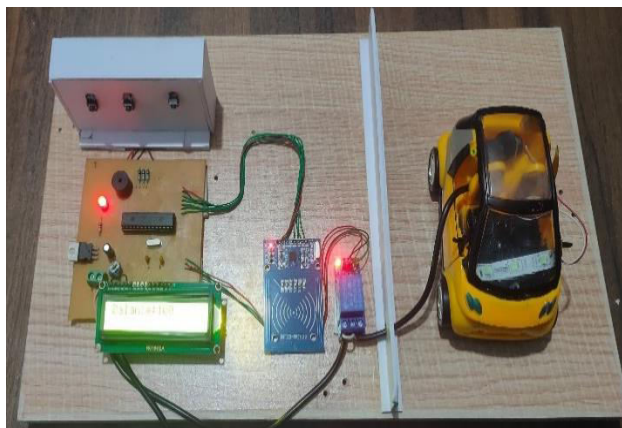

Fig 4: System prototype of RFID based EV charging station.

STEP 4: After that system ask to press button to start the charging so we have to press button to start charging as per our decision.

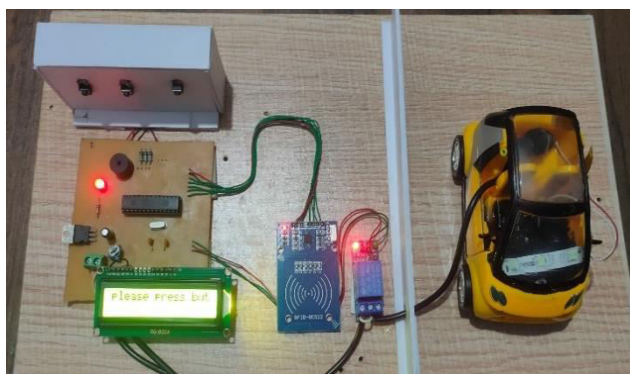

Fig 5: System prototype of RFID based EV charging station.

STEP 5: When we select and press button then charging get started and msg displays on LCD that charging is started.

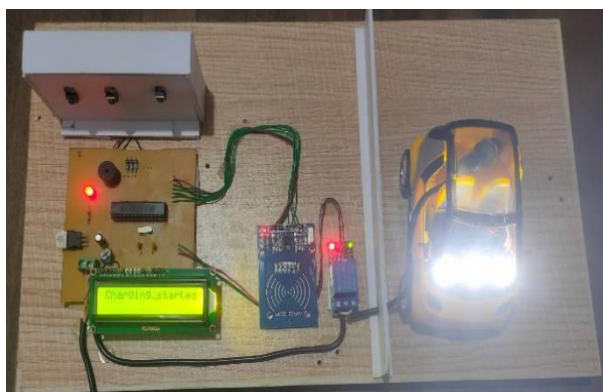

Fig 6: System prototype of RFID based EV charging station.

STEP 6: Once the selected time completes then charging automatically stops and msg displays on LCD that charging stopped.

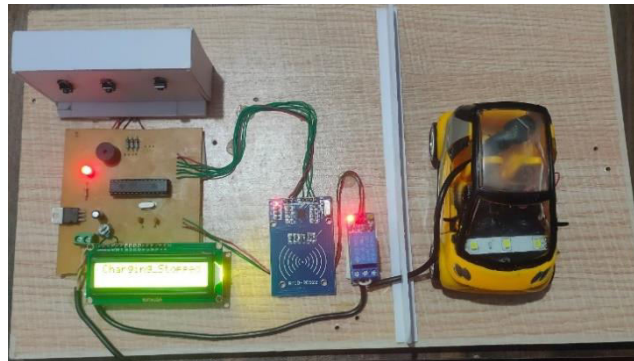

Fig 7: System prototype of RFID based EV charging station.

V. SYSTEM OVERVIEW

RFID-based EV charging stations utilize Radio Frequency Identification technology to manage access and billing for electric vehicle charging. Here's a system overview:

RFID Reader: Each charging station is equipped with an RFID reader that communicates wirelessly with RFID cards or tags.

RFID Cards/Tags: Users are issued RFID cards or tags which they use to access the charging station. These cards or tags contain unique identification numbers that are linked to the user's account.

User Authentication: When a user approaches the charging station, they present their RFID card or tag to the reader. The reader then verifies the user's identity by checking the unique ID against a database.

Access Control: If the user is authorized, the charging station grants access to initiate the charging process. Otherwise, access is denied.

Charging Process: Once access is granted, the user plugs in their electric vehicle and the charging process begins.

Data Transmission: Throughout the charging session, data such as charging duration, energy consumed, and user information is transmitted wirelessly to a central server for monitoring and billing purposes.

Billing and Payment: At the end of the charging session or periodically, the central server calculates the charging fees based on the energy consumed and any applicable tariffs. Users are then billed accordingly, either through a prepaid system or invoicing.

Remote Management: Operators of the charging network can remotely monitor and manage the charging stations, including troubleshooting issues, updating software, and analyzing usage data.

Integration with EVSE: The RFID system is integrated with the Electric Vehicle Supply Equipment (EVSE) to control the charging process, monitor power consumption, and ensure safety standards are met.

Security: To ensure the security of user data and transactions, the system employs encryption protocols and secure communication channels between the RFID reader, central server, and EVSE.

Overall, RFID-based EV charging stations provide a convenient and secure method for managing access to charging facilities while enabling efficient billing and monitoring capabilities.

VI. CONCLUSION

We have implemented an automatic text detection technique from an image for inpainting. Our algorithm successfully detects the text region from the image which consists of mixed text-picture-graphic regions. We have applied our algorithm on many images and found that it successfully detects the text region.

The RFID-based EV charging station demonstrates an effective, secure, and user-friendly solution for managing electric vehicle (EV) charging sessions. By integrating RFID technology, the system ensures that only authorized users can access the charging facility, enhancing security and reducing unauthorized usage. The use of RFID cards simplifies the user authentication process, providing a hassle-free experience.

REFERENCES

- [1] C. Chan and K.T. Chau, Modern Electric Vehicle Technology, Oxford University Press.
- [2] Sunit Baviskar, Shubham Mandlik, Deepak Marsale, Prof. Kirti Kulkarni “RFID Based EV Charging Station” 2022 International Journal of Research in Engineering and Science
- [3] Ajithkumar, M. Ajithkumar, S. Gopi, V.G. Balajisabarinathan, Mr. C. Gowrishankar “SMART E-VEHICLE CHARGING SYSTEM USING RFID” 2020 International Journal of Research and Analytical Reviews
- [4]<https://www.niti.gov.in/sites/default/files/202108/HandbookforEVChargingInfrastructureImplementation081221.pdf>
- [5] Maria Carmen Falvo, Danilo Sbordone and I. Safak Bayram, Michael Devetsikiotis, “EV Charging Stations and Modes: International Standards”, 2014 International



International Journal of Advanced Research in Education and Technology

ISSN: 2394-2975

Impact Factor: 7.394